

pc_o.flim camera system

fluorescence (luminescence) lifetime imaging application simplified

lifetimes from
100 ps to 100 μ s

high frame rate
45 double frames/s

frequency synthesizer
5 kHz - 40 MHz

unique resolution
1008 x 1008 pixels



pc_o.

An Excelitas Technologies Brand

FLUORESCENCE LIFETIME IMAGING – APPLICATION SIMPLIFIED...

For many years the phenomenon of photoluminescence has been used for a variety of purposes in life science applications, ranging from bio markers to sensing applications. Each of the luminophores that are applied has multiple characteristic parameters, which can be exploited for investigations.

The most prominent parameter is the luminescent emission itself, the fluorescence or phosphorescence intensity. The intensity is used qualitatively and quantitatively, but the latter strongly depends on the light field and the optical conditions around the luminophore. Similarly it is known that the luminescence decay or lifetime is an additional characteristic parameter of such a dye, which can provide additional information (see figure 1 and 5) or more reliable information than the luminescence intensity.

Although the possibilities of the luminescence lifetime have been known for many years, only few commercial camera systems are available. There are image intensifier based camera systems for frequency domain FLIM or scanning systems for time domain FLIM and camera based systems for time domain FLIM for longer lifetimes (range of microseconds and longer). Additional equipment such as frequency or timing generators was required to create such systems, which in many cases were quite bulky and expensive. Due to technical developments in the area of CMOS image sensors, it is now possible to manufacture image sensors whose pixels can be directly modulated up

to 40 MHz, which is an excellent prerequisite for the design of an all solid-state frequency domain FLIM camera system. Based on such a new CMOS image sensor, a highly integrated frequency domain FLIM camera system has been developed, which reduces efforts and costs of luminescence lifetime imaging systems. The principle is based on a charge swing in each pixel which allows for a very fast change of the direction of the luminescence induced charge carriers. In case of the pco.flim camera system it allows for modulation frequencies of up to 40 MHz.

If a luminophore is excited by a sinusoidally modulated light it will react with a sinusoidal emission of light, but the reaction will be delayed due to the luminescence lifetime. This delay, technically called a phase angle between the excitation and emission, can be measured. Figure 2 shows the charge swing of the pixel, how it synchronizes with the integration of half the sinus signal and how it can be used to measure the phase angle of the emission.

While the switch in the pixel points to tap A, all generated charge carriers are collected there; this is done to integrate along half of the period of the sinusoidal emission, then the switch changes direction, and the second half period is integrated into tap B. The first integral corresponds to the phase angle value of 0° (tap A) and the second integral corresponds to a phase angle value of 180° (tap B). To reconstruct the sinusoidal signal and determine the phase angle, at least one second measurement is required.

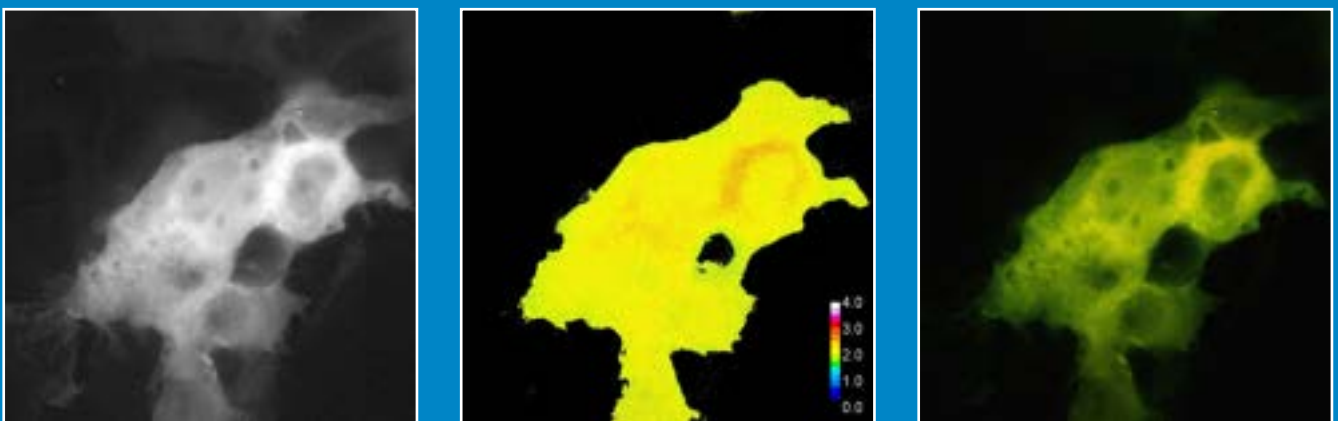

Figure 1: The left photo shows the fluorescence intensity of HEK-293 cells which expressed a CFP/DJ-1 protein as control of a FRET experiment. The middle image shows the phase angle derived distribution of fluorescence lifetimes in the range of 0 – 4 ns (imageJ LUT 16 colors, colorbar 0 – 4 ns) which has been masked by an intensity filter. The range of lifetimes around 2 ns was found in all of the 26 cells, which have been measured and showed about 10% FRET efficiency compared to the pure CFP expression. The right image shows the lifetime distribution image weighted by the fluorescence intensity image (the color images are false color coded using the same colorbar and LUT) without mask (courtesy of Prof. Dr. F.S. Wouters and Dr. G. Bunt, University Medicine Göttingen).

FLUORESCENCE LIFETIME IMAGING – APPLICATION SIMPLIFIED...

Therefore a phase angle offset of $\Delta\Phi = 90^\circ$ is introduced between the excitation and the emission, and the measurement is repeated (lower signal in figure 2). Now the integrals correspond to the phase angles of 90° (tap A) and 270° (tap B). With these values or images it is possible to calculate three images: an image of the luminescence intensity, an image of the phase angle distribution and an image of the modulation index distribution. The latter two can be converted into luminescence lifetime distributions. Since one integration in most cases is not enough, the integration is repeated until sufficient signal is collected, which means that during an exposure time of for example 100 ms, the switch is triggered with the modulation frequency.

Fluorescence lifetime imaging set-up

Now the devices needed for a fluorescence lifetime imaging measurement are the new pco.flim camera and the light source pco.flim laser that can use the modulation signal and the dark gate signal coming from the camera. In principle, that is all that is needed. Figure 3 shows a structural overview of a set-up for luminescence lifetime imaging with a pco.flim camera system, in which the camera is the frequency master. The pco.flim camera sends the modulation signal and the dark gate signal to the light source, which should be capable of accepting both signals.

While the modulation signal controls the modulation of the excitation light, the gate signal controls whether the excitation light in general is switched ON or OFF, because the

light has to be switched OFF during image readout time¹. It depends on the application which modulatable light source (fig. 3) is appropriate (required frequency range), which can be anything from LED to laser diodes that can be properly modulated in the intended frequency range. The modulated light can pass an optical excitation light filter (fig. 3, excitation filter) and will excite the luminophore in the sample of interest.

For that purpose it might be necessary to add additional optics to guide and shape the light to the sample. The optics are not included in the overview. The luminescent sample in turn will emit luminescence light. This light has to pass some sort of optical emission filters (fig. 3, emission filter) and will be imaged by optics (fig. 3, imaging optics) to the image sensor of the pco.flim.

It is not important whether the emission has to first pass the optics and then the filter or vice versa; figure 3 shows just one version. The optics can range from lenses to microscopes, depending on the application. According to the operation modes and settings, the pco.flim camera system will transfer the images to the controlling computer (fig. 3, computer) via the USB 3.0 data interface. The examples given in figure 3 are just placeholders to show the flexibility of the pco.flim system. Since the camera includes the generation and control of the modulation signals, the overall set-up is reasonably simple.

¹The QMFLIM2 Image Sensor catches additional noise, when light shines on the image sensor during readout.

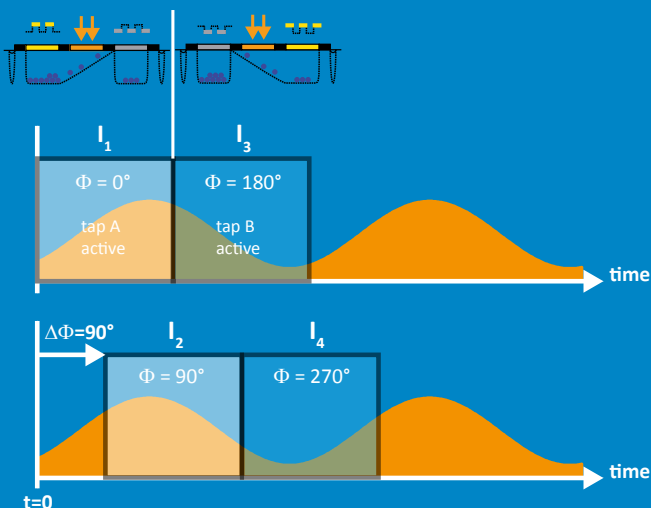

Figure 2: Sinusoidal luminescence signal (orange) with sampling integration windows (grey rectangles). At first, for Image I_1 the first half of the period is integrated, which corresponds to tap A is active and $\Phi = 0^\circ$, and subsequently the image I_3 is integrated, which corresponds to tap B is active and $\Phi = 180^\circ$. For the next recording the synchronization is shifted by $\Delta\Phi = 90^\circ$, such that the first half period of integration covers I_2 , which corresponds to tap A is active and $\Phi = 90^\circ$, and subsequently the image I_4 is integrated, which corresponds to tap B is active and $\Phi = 270^\circ$.

FLUORESCENCE LIFETIME IMAGING – APPLICATION SIMPLIFIED...

Frequency vs. time domain luminescence lifetime measurements

In theory there is no difference regarding the information content of the two types of decay or lifetime measurements, since both methods give the same results, but with different experimental requirements.

The frequency domain measurement requires a reference measurement to cancel out the influence of the optical path, which might not be necessary for the time domain measurement, but time domain measurements with image sensors are not possible down to the nanosecond range, since the fastest available CMOS image sensors still have minimum exposure times of more than 100 nanoseconds, while the frequency domain camera system pco.flim, even at a modulation frequency of 30 MHz, can resolve 100 picoseconds. For example the differences between the pollen grains (yellow in figure 5 middle image) and the leaf cells (blue and green in figure 5 middle image) were in the range of 1.2 ns.

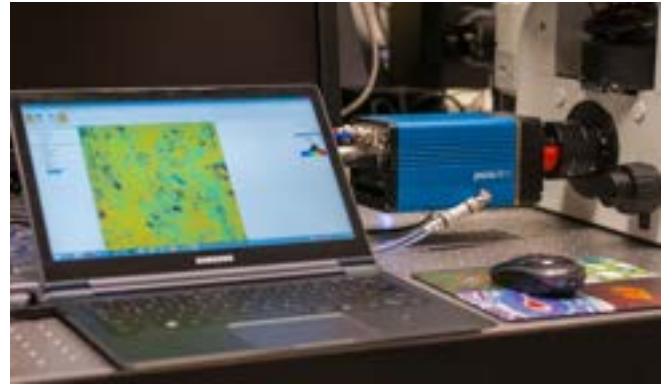

Figure 4: The pco.flim FLIM camera system attached to the camera port of an inverted microscope with the controlling PC.

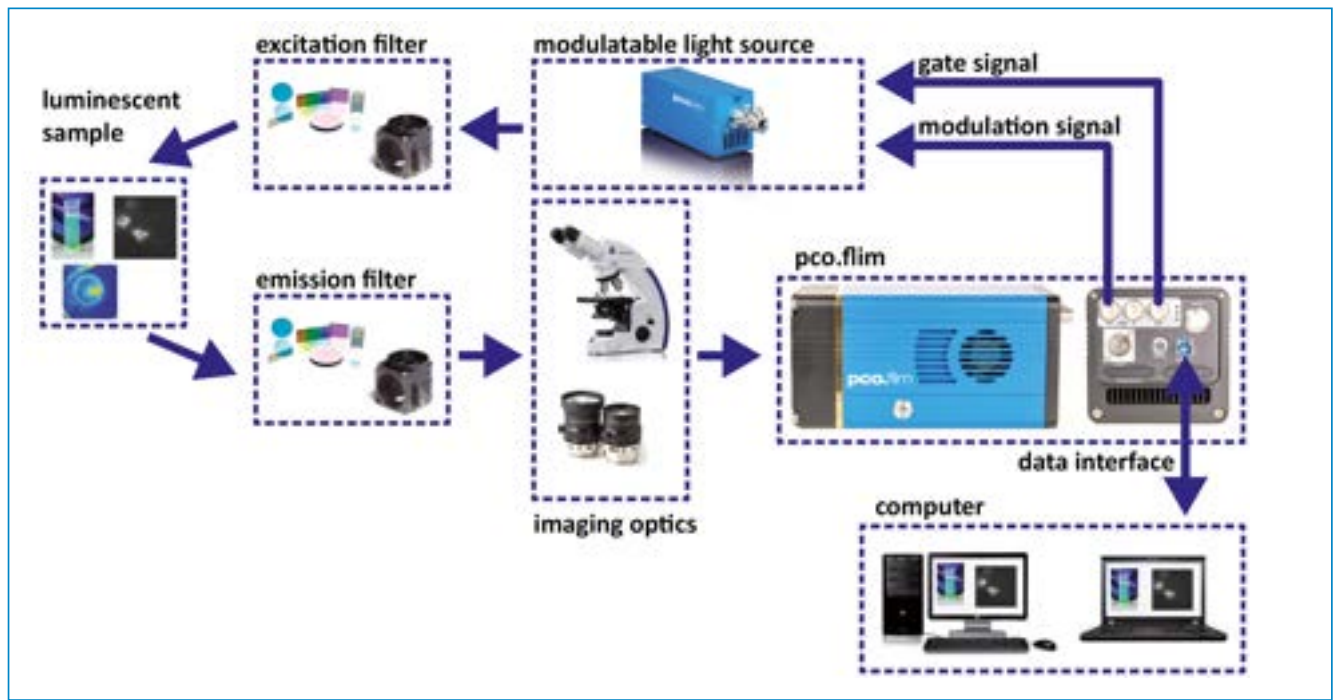

Figure 3: Structural overview of a set-up for luminescence lifetime imaging with a pco.flim camera system.

FLUORESCENCE LIFETIME IMAGING – APPLICATION SIMPLIFIED...

pco.flim camera system

The pco.flim camera system, consisting of pco.flim camera and pco.flim laser, includes a complete frequency synthesizer, which is required for the generation of the modulation signals in the frequency domain.

The pco.flim has a resolution of 1008 x 1008 pixels and can read out a maximum of 45 double frames/s. The effective frame rate is about 20 frames/s, due to the fact that a minimum of 2 double frames have to be read out for a proper sine fit and this has to be done twice for a proper asymmetry correction. The camera system can be operated at a single frequency or multiple frequencies in the range of 5 kHz – 40 MHz and it can perform an asymmetry correction even before image readout.

With its widely used USB 3.0 interface it can connect to all sorts of computers. A thermo-electrical Peltier cooler keeps the image sensor at 5 °C by using either a fan or a water cooler to dissipate its own lost heat. With the C-mount it is easy to connect to any microscope or lens. Therefore the camera system significantly reduces the required efforts and costs for operation and research.

Application simplified

Integrated into an optimized software environment the measurement of 2D fluorescence lifetime distributions now has been simplified. Instead of an image intensifier camera, light source and timing or frequency generators, the application requires only a CMOS camera and a light source, which should enable a broad range of applications that were previously not feasible due to the complexity of the existing system requirements.

Therefore, numerous applications, including FRET applications for measuring the donor fluorescence to determine how much FRET has occurred, the measurement of auto-fluorescence lifetimes in natural tissue or the measurement of the luminescence lifetime for sensing purposes, ranging from optical chemical sensors on a cellular scale up to the use of pressure sensitive paint in wind tunnels, can all benefit from the new FLIM system.

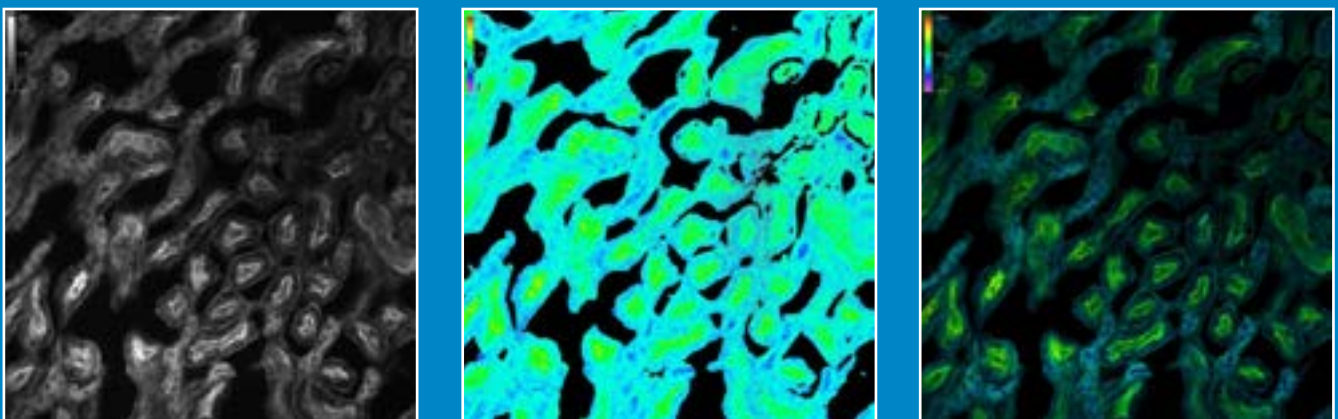
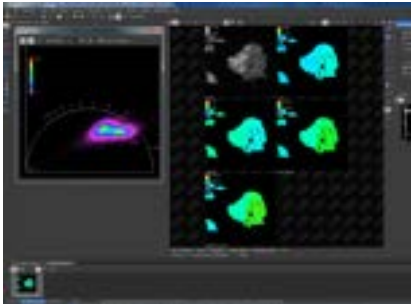

Figure 5: A ThermoFisher FluoCells® prepared slide, which contains a section of mouse kidney stained with a combination of fluorescent dyes. The visible marker is Alexa Fluor® 488 wheat germ agglutinin, a green-fluorescent lectin, which was used to label elements of the glomeruli and convoluted tubules, which were excited with 488 nm at a modulation frequency of 30 MHz. The left image shows the fluorescence intensity of the mouse kidney sample (20x air objective). The middle image shows the phase angle derived distribution of fluorescence lifetimes of the Alexa Fluor 488® in the range of 1.5 – 3.5 ns (NIS Elements, colorbar 1.5 – 3.5 ns). The right image shows the lifetime distribution image weighted by the fluorescence intensity image.

FLUORESCENCE LIFETIME IMAGING – APPLICATION SIMPLIFIED...

Applications



Seamlessly integrated into Nikon NIS Elements AR software to use the pco.flim camera for homodyne frequency domain fluorescence lifetime imaging with all referencing and phasor plot feedback.

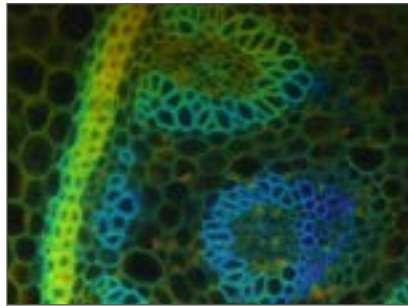

Endogenous fluorescence of a Convallaria (lily of the valley) slice sample. The image shows the endogenous fluorescence lifetime distribution derived from the measured phase angle in false color coding and weighted by the fluorescence intensity. The displayed lifetimes range from 0.5 - 4 ns.

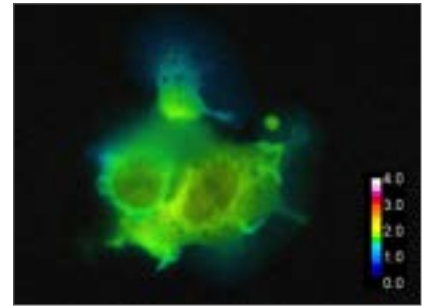

HEK-293 cells co-expressing a fusion protein with Cyan Fluorescent Protein (CFP) and with Yellow Fluorescent Protein (YFP). Dimerization of this protein is detected by FRET as judged by the reduction in CFP lifetime. The image shows the fluorescence lifetime distribution derived from the measured phase angle in false color coding and weighted by the fluorescence intensity. The displayed range is from 0 – 4 ns (see color bar, courtesy of Prof. Dr. F.S. Wouters and Dr. G. Bunt, University Medicine Göttingen).

Dimensions

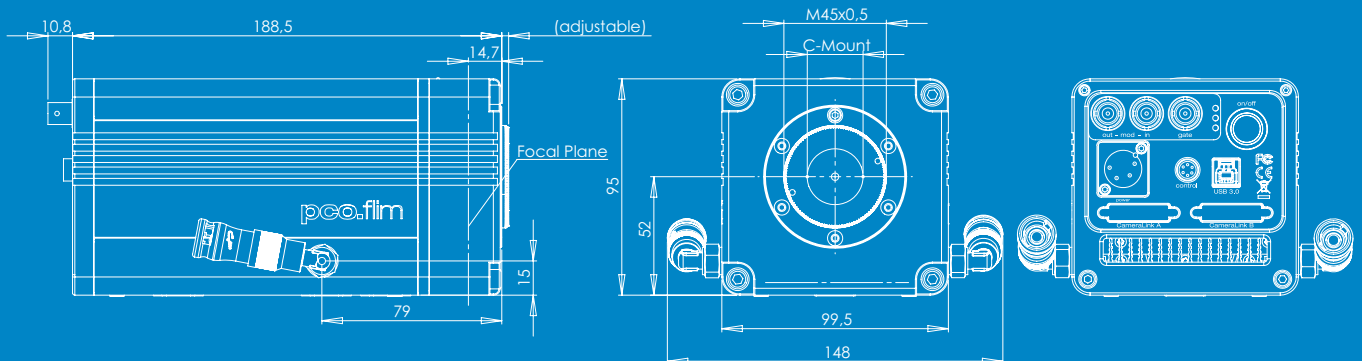

FLUORESCENCE LIFETIME IMAGING – APPLICATION SIMPLIFIED...

Technical Data Camera System

The pco.flim camera system is the first luminescence lifetime imaging camera using a new modulatable CMOS image sensor. It offers all the required generation of frequency domain signals (5 kHz – 40 MHz) and also allows the use of external modulation signals in a limited frequency range (500 kHz – 40 MHz).

image sensor

type of sensor	CMOS
image sensor	proprietary
resolution (h x v)	1008 x 1008 pixels
pixel size (h x v)	5.6 μm x 5.6 μm
sensor format / diagonal	5.7 mm x 5.7 mm / 8.1 mm
shutter mode	rolling reset / global exposure
fullwell capacity	52 000 e ⁻ (typ.)
readout noise	48 e ⁻ rms (typ.)
dynamic range	> 1 000 : 1 (60 dB)
quantum efficiency	appr. 39 % @ peak
spectral range	370 nm ... 780 nm (FWHM)
dark current	1220 e ⁻ / (s.pixel)
DSNU	56 e ⁻ rms
PRNU	0.7 %

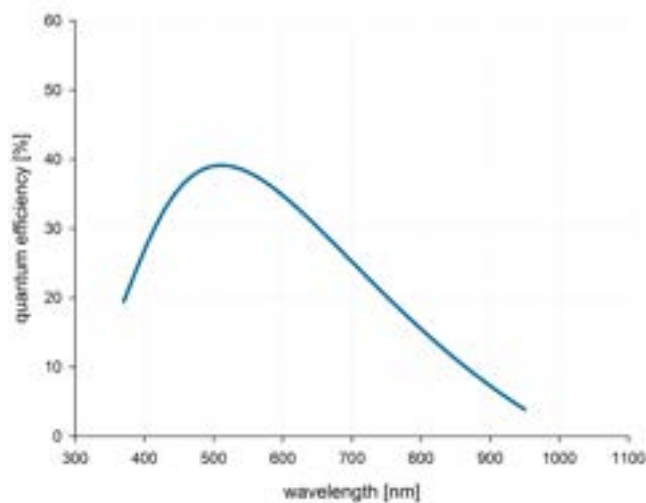

It has a USB 3.0 interface for image data transfer and control of all camera operation modes. Further, a variety of trigger input / output signals for integration of the camera into any application framework is available. The next tables gives an overview of the performance data of the camera system.

camera

max. frame rate (full frame, full resolution)	45 double frames per s (2 tap readout)
modulation frequency	internal 5 kHz ... 40 MHz external 500 kHz ... 40 MHz
modulation signal shape	sinusoidal / rectangular
exposure / shutter time	1 ms ... 2 s
dynamic range A/D	14 bit
A/D conversion factor	3.4 e ⁻ /count
region of interest	steps of 16x1 pixel
thermoelectrically cooled	+5 °C
nonlinearity	< 1 %
trigger input signals	exposure start (phase sequence trigger)
trigger output signals	exposure, busy, gate (light enable)
modulation signal output	1 V _{peak-peak} in 50 Ω , AC coupled
modulation signal input	max. +/- 5 V in > 1 k Ω
data interface	USB 3.0

general

power supply	90 ... 260 VAC (12 VDC opt.)
power consumption	40 W max.
weight	2.4 kg
ambient temperature	+5 °C ... +40 °C
operating humidity range	10 % ... 90 % (non-condensing)
storage temperature range	-20 °C ... +70 °C
optical interface	C-mount
CE / FCC certified	yes



FLUORESCENCE LIFETIME IMAGING – APPLICATION SIMPLIFIED...

pco.flim laser

The pco.flim laser is an excitation and illumination light source designed for use with the FD-FLIM pco.flim camera system. It features a digital (square wave) modulation frequency range of 0 – 250 MHz, which ideally covers the modulation frequency range of 5 kHz – 40 MHz offered by the pco.flim camera. There is a full range of different wavelengths available (375 nm – 395 nm – 405 nm – 445 nm – 473 nm – 488 nm – 515 nm – 638 nm). The system is optimum suited for the measurement of fluorescence lifetimes in the range of nanoseconds.

System connections

There are different optimal cabling connections between the pco.flim camera system and the pco.flim laser, depending on the main application the system should be used for. In case the fluorophores are reasonably stable and the samples are fixed (non-living) the camera and the laser should be connected in the following way:

The modulation output [mod - out] signal of the camera (see fig. 6) should be connected to the digital input [Digital] of the laser by means of a coaxial 50 Ohm cable. The dark gate [gate] output signal of the camera should be connected to the laser enable [Laser Enable] input signal of the laser with a similar cable.

If the laser control software settings are done properly, this connecting scheme achieves to switch OFF the laser for image readout only, which means, that even when no images are recorded the laser light is switched ON, which helps for looking at the sample with the eyes. In case photo bleaching of the fluorophores should be minimized, then for example the mechanical shutter of the microscope should be used to stop the illumination, or the control software can be used to switch OFF the laser or turn it to standby.

For living cell measurements, for fast bleaching fluorophores and for time lapse measurements, the excitation light impact on the samples has to be minimized, therefore preferably the excitation light should be only ON, when images are recorded. For that purpose the pco.flim camera also has a breakout cable which connects to the “control” connector on the back plane of the camera. There is an exposure output [exposure] signal of the camera which should be connected instead of the gate output signal to the laser enable [Laser Enable] input signal of the laser (see fig. 7).

If the laser control software settings are done properly, this connecting scheme achieves to switch ON the laser ONLY for image exposures, which means that the excitation light is always switched OFF if no images are recorded. In case the user wants to switch the light ON for orientation in the sample, the camera has to be used in preview mode (NIS Elements “Find”), then continuously images are recorded and the “flickering” light (for image readout the light is switched OFF) can be used to pick out a location of interest in the sample or to focus the sample plane properly.

pco.flim laser options

The pco.flim laser can either be ordered for homogeneous illumination of the sample in a widefield microscope application with a 3 mm liquid light guide cable, or it can be ordered for applications like Total-Internal-Reflection-Fluorescence (TIRF) microscopy, light sheet fluorescence microscopy (LSFM) and confocal spinning disk microscopy equipped with a kineflex adapter and a single mode fiber optic cable. Especially for Nikon microscope applications it can be ordered with the Nikon double-safety-shutter option.

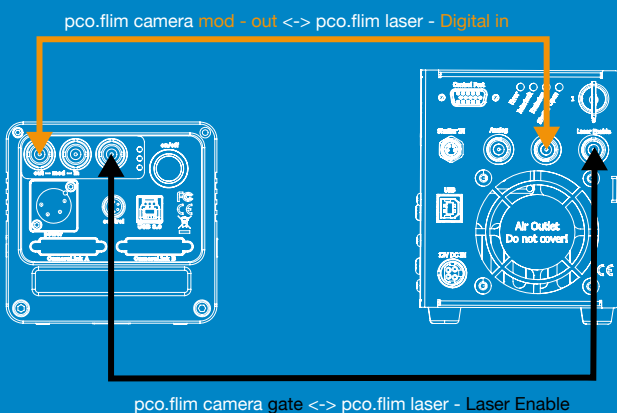

Figure 6: Cable connection scheme between pco.flim camera and laser if fixed samples should be measured with single measurements.

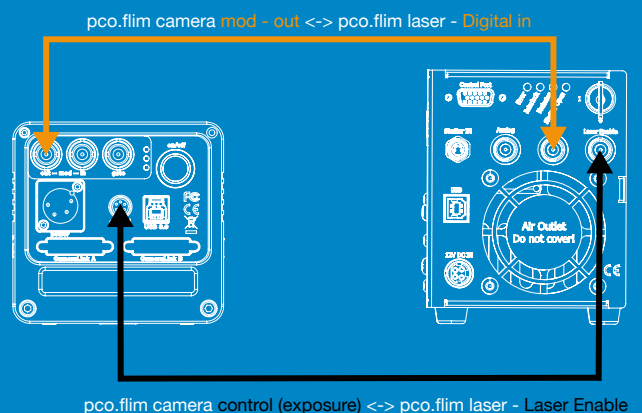

Figure 7: Cable connection scheme between pco.flim camera and laser if time lapse or living cell measurements should be made.

FLUORESCENCE LIFETIME IMAGING – APPLICATION SIMPLIFIED...

Technical Data Laser

wavelengths & powers (selectable; other wavelengths and powers on request)	<ul style="list-style-type: none"> • 375 nm / 70 mW • 395 nm / 120 mW • 405 nm / 120 mW • 445 nm / 100 mW • 473 nm / 100 mW • 488 nm / 100 mW • 515 nm / 100 mW • 638 nm / 150 mW
opto-mechanical interface (selectable)	<ul style="list-style-type: none"> • 3 mm liquid light guide • FC/APC • FC/PC • FCP8 • 0.7 mm collimated beam
long term power stability	< 0.5 % / 8 h
RMS noise 20 Hz .. 20 MHz	< 0.2 % (CW)
analogue modulation input signal type	> 3 MHz (0.5 V @ 1.2 kOhm or 0..1 V @ 50 Ohm - user configurable)
digital modulation input signal type	> 250 MHz (+/- 0.5 V @ 50 Ohm)
laser enable (electronic shutter) input signal type	> 500 kHz (full ON/OFF) (LV-TTL @ 2 kOhm)
operation modes:	
mode 1	CW operation (ACC - automatic constant current)
mode 2	CW operation (ACC - automatic power control)
mode 3	analogue modulation
mode 4	digital modulation
mode 5	analogue + digital modulation
rise and fall time	analogue < 100 ns digital < 1.5 ns laser enable < 100 ns
extinction ratio	analogue > 1000 : 1 digital > 250 : 1 laser enable: infinite (full ON/OFF)
supply voltage	12.0 VDC +/- 0.5 VDC
control interface	USB 2.0
dimensions (l x w x h)	270 mm x 92 mm x 116 mm
additional shutter	optional: Nikon laser safety shutter

laser safety classification



contact

pco europe

+49 9441 2005 50
info@pco.de
pco.de

pco america

+1 866 678 4566
info@pco-tech.com
pco-tech.com

pco asia

+65 6549 7054
info@pco-imaging.com
pco-imaging.com

pco china

+86 512 67634643
info@pco.cn
pco.cn



for application stories
please visit our website

pco.

An Excelitas Technologies Brand



info@microscopeworld.com | 800-942-0528