



MT6000 Series Microscope Instruction Manual

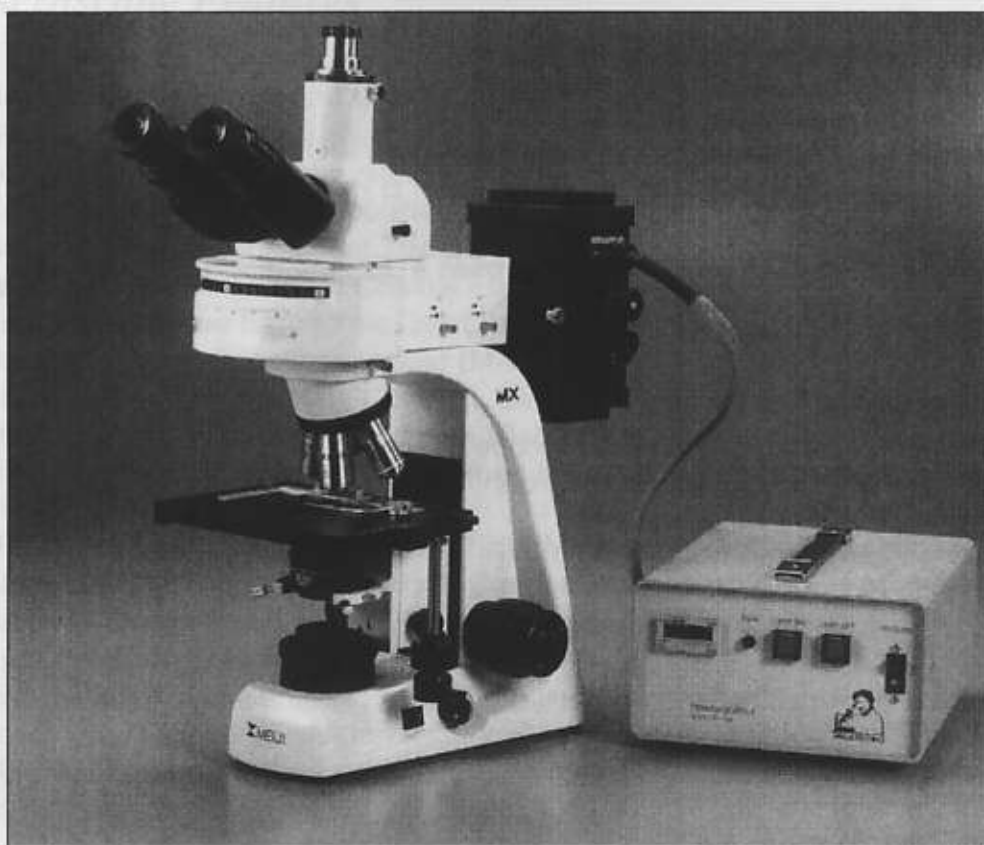

Table of Contents

- 1.0 Introduction
- 1.1 Microscope Features
- 1.2 General Safety Guidelines
- 1.3 Warning/Caution symbols used in this manual
- 1.4 Intended Product Use Statement
- 1.5 Product Safety Information - Handling the microscope
- 1.6 Warranty Statement

- 2.0 The Microscope and its Components
- 2.1 Installation Site
- 2.2 Unpacking
- 2.3 Microscope Set Up
- 2.4 Adjusting Interpupillary Distance
- 2.5 Fluorescence Filters Information
- 2.6 UV Light Safety Considerations

- 3.0 Microscope Operation
- 3.1 Incident Light Operation – Epi-Fluorescence
- 3.2 Transmitted Light Operation – Brightfield
- 3.3 Installing Phase Contrast Components
- 3.4 Transmitted Light Operation – Phase Contrast
- 3.5 Photomicrography with 35mm SLR and Digital SLR Cameras
- 3.6 Photomicrography with Digital Still Cameras
- 3.7 Connecting a Video or Other Camera that uses a "C" type mount

- 4.0 Maintenance and Cleaning

- 5.0 Troubleshooting
- 5.1 Replacing the mains fuse on the microscope
- 5.2 Integrated Transmitted Light does not work
- 5.3 Replacing the 6V 30W Halogen Light
- 5.4 Fluorescence Lamp does not work
- 5.5 Replacing the Fluorescence Lamp

- 6.0 Storage

- 7.0 Packing and Transport
- 8.0 Accessories and Replacements Parts
- 9.0 Technical Descriptions
- 10.0 Physical Dimensions

MT6000 Series Biological Microscope

1.0 Introduction

The Meiji Techno MT6000 Series biological microscopes have a modern compact design. Easy operation is achieved through ergonomic placement of the microscope controls making them ideal for use in production, education and clinical applications.

Meiji's MT6000 Series is well suited for a wide variety of routine and clinical applications such as cell observation, epi-fluorescence observation as well as high resolution video microscopy.

The MT6000 Series Microscopes offer crisp, distortion-free, high resolution images in multiple modes of operation. Contrast methods available include: Brightfield, Darkfield, Phase Contrast, Simple Polarization and Epi-Fluorescence.

1.1 Microscope Features

- CAD Designed Frame and Optics
- Slim Compact Footprint
- Infinity Corrected Optical System
- New and improved Semi Apo Plan Objectives
- Ceramic Coated Clinical Flat Top Stage with optional specimen holder
- Low Positioned Ergonomic Coaxial Focus Controls
- Smooth Operating Ergonomic Quintuple Nosepiece
- Optional Clinical Specimen Holder (MA676)
- Brightfield/Darkfield, Phase Contrast, Simple Polarized Light and Epi-Fluorescence Observation Modes available
- Integrated 30-watt Halogen Transmitted Illumination System on Brightfield and Phase Contrast Models
- Modular Six Position Fluorescence Filter Module with 3 filter sets included
- Abbe, Zernike Phase and Darkfield Condensers available
- Siedentopf-type Binocular and Trinocular Viewing Heads
- Super Wide High Eyepoint Eyepieces
- Automatic Voltage Sensing Power Supply for transmitted light with detachable power cord (FL-PWJ Epi-fluorescence Power Supply for 115V or 220/240V)
- FL-LHJ Fluorescent Lamphouse accepts 100W Mercury lamp
- Wide Range of Filters and Accessories

1.2 General Safety Guidelines

This manual contains important safety instructions and information concerning the installation, operation and maintenance of the Meiji Techno MT6000 Series biological microscopes.

This manual should be read carefully before any attempt is made to operate this equipment. To ensure safe operation the user must read and adhere to all of the directions put forth in this manual.

Meiji Techno products are designed for safe operation under normal operating conditions. The instrument and accessories described in this manual have been built and tested according to industry safety standards for electronic laboratory instruments. Incorrect usage or non-conformance to operating instructions can cause personal injury or damage to equipment or property.

Keep this manual near your instrument for easy reference.

1.3 Warning/Caution Symbols Used in this Manual

You must be aware of all safety issues when you install and operate this microscope system. Several warning and caution symbols are listed below. These symbols are used throughout this instruction manual. For your safety, be sure to follow all instructions associated with the symbols listed below.

 **DANGER** Disregarding instructions marked with this symbol may lead to serious bodily injury or possibly death.

 **WARNING** Operational warning; failure to operate equipment properly may result in damage or injury.

 **WARNING** Possible electrical shock hazard exists

 **CAUTION** Disregarding instructions marked with this symbol may lead to serious injury or property damage.

 **HOT!** Caution for heat or hot surfaces. Risk of burns or serious injury!

 **NOTE** This symbol designates technical note or product tip.

1.4 Intended Product Use Statement

Product Disclaimer: This product is designed and intended for use only as a biological microscope system. Modifying this instrument in any way for use in any situation other than the original and intended product design will automatically void the warranty. In no event shall Meiji Techno be liable to any person for any incidental, indirect or consequential damages, arising out of or in connection with the use or performance of a modified or altered product.

1.5 Product Safety Information- Handling the Microscope

 **WARNING** This microscope is not intended to be used in the immediate vicinity of water or a water outlet or placed in any location where water may penetrate the instrument. Water penetration may result in electrical shock or death. Choose only a suitable environment for your microscope.

Do not subject the microscope to extreme temperature fluctuations. Extreme temperature changes may lead to condensation within the microscope which may result in damage to the optical and electrical components.

Disassembly of the instrument may result in electrical shock, injury or death, equipment damage, loss of warranty coverage or may create other potential hazardous consequences.

Always turn off the power switch and disconnect the cord from the power supply when replacing fuses, connecting or disconnecting wiring, doing general maintenance or replacing the microscope lamp.

 **WARNING**

DO NOT OPERATE UNLESS THE UNIT IS PROPERLY GROUNDED!

Use only the specified power cord in a well grounded socket. Do not use in an ungrounded power receptacle or in cases where there is a break in the ground conductor or damage to the electrical wiring.

Only fuses of the specified type and rating are to be used as replacements. Switch off the power and disconnect the power cord before replacing fuses. Use of a non-compliant fuse may result in electrical shock or severe damage your equipment.

The lamp and lamp house become extremely hot during and after operation. Do not place any highly flammable or volatile material close to the lamp-house during or after operation. Do not touch the lamp house or attempt to replace the bulb for at least 30 minutes after the unit has been turned off or injury may result.

Do not obstruct the air vents on the lamp-house or power supply. The lamp housing and power supply should must be located at least 10 cm (4 inches) away from the wall or any combustible objects.

Modifying the instrument in any way or unauthorized attempts to disassemble or use the instrument for applications other than its intended design will automatically void the warranty.

1.6 Warranty Statement

Meiji Techno warrants this product against defects in material and/or workmanship for the life of the instrument from the date of the original purchase to the original purchaser. Meiji Techno will repair or replace, at its option, any instrument which under normal conditions of use and service proves to be defective in material or workmanship. No charge will be made for labor or materials with respect to defects covered by this warranty, provided all repair work is done by Meiji Techno.

This warranty does not cover expenses incurred in the removal or reinstallation of any instrument or instruments, whether or not proven defective. Replacement or repairs furnished under this warranty are subject to the same terms and conditions of the original warranty. This warranty supersedes any other warranty and is subject to the following terms and conditions:

WARRANTY

Warranty of Meiji Techno's product extends to the original purchaser of the product and is not transferable.

WARRANTY DURATION

Meiji Techno warrants this product against defects in material and/or workmanship for the life of the instrument from the date of original purchase to the original purchaser. The electrical warranty is 90 days.

OWNER'S REGISTRATION CARD

Return of the owner's registration card by the original purchaser within ten (10) days after the original purchase is a condition precedent to coverage under this warranty. Meiji Techno will at its option accept written proof of purchase from the original owner in lieu of a product registration card.

EXCLUSIONS AND LIMITATIONS

Specifically excluded from this warranty are failures caused by abuse, neglect, misuse, improper operation, normal wear, accident, improper maintenance or modifications of ANY type. This warranty does not cover repair or replacement where normal use has exhausted the life of a part or instrument. All mechanical devices need periodic parts replacement and service to perform well. Service life of an instrument is dependent upon the care it receives and the conditions under which it has to operate. In no event shall Meiji Techno be liable for incidental or consequential damages.

SERVICE

To obtain service under this warranty, please contact Meiji Techno directly and ask for the Product Service Department. State the nature of the problem, model and serial number of the instrument, date of purchase and location and name of the distributor the instrument was purchased from. After verification of warranty registration, Meiji Techno will issue a return authorization number. Customer may then return the product postage prepaid and insured to the authorized repair facility.

In most instances, requests for warranty service will be performed in a prompt and routine manner and merchandise will be returned in a reasonable period of time or at Meiji Techno's convenience. In some cases, requests for warranty service are received which are not justified. In these cases, Meiji Techno will provide an explanation for non-warranty action.

WARRANTY TERMS

The terms of this warranty may not be varied by any person, whether or not purporting to represent or act on behalf of Meiji Techno. The limited lifetime warranty provided is in lieu of any and all warranties, expressed or implied, whether for merchantability or fitness for a particular purpose or otherwise. Liability for consequential damages under any, and all warranties are excluded to the extent exclusions are permitted by law. This warranty gives you specific legal rights and you may also have other rights which vary from state to state. This warranty sets forth the customer's exclusive remedy, with respect to defective products. This limited warranty shall become null and void in the event of a violation of the provisions of this limited warranty.

2.0 The Microscope and its Components

The image below designates the main components of the MT6000 Series Microscope.

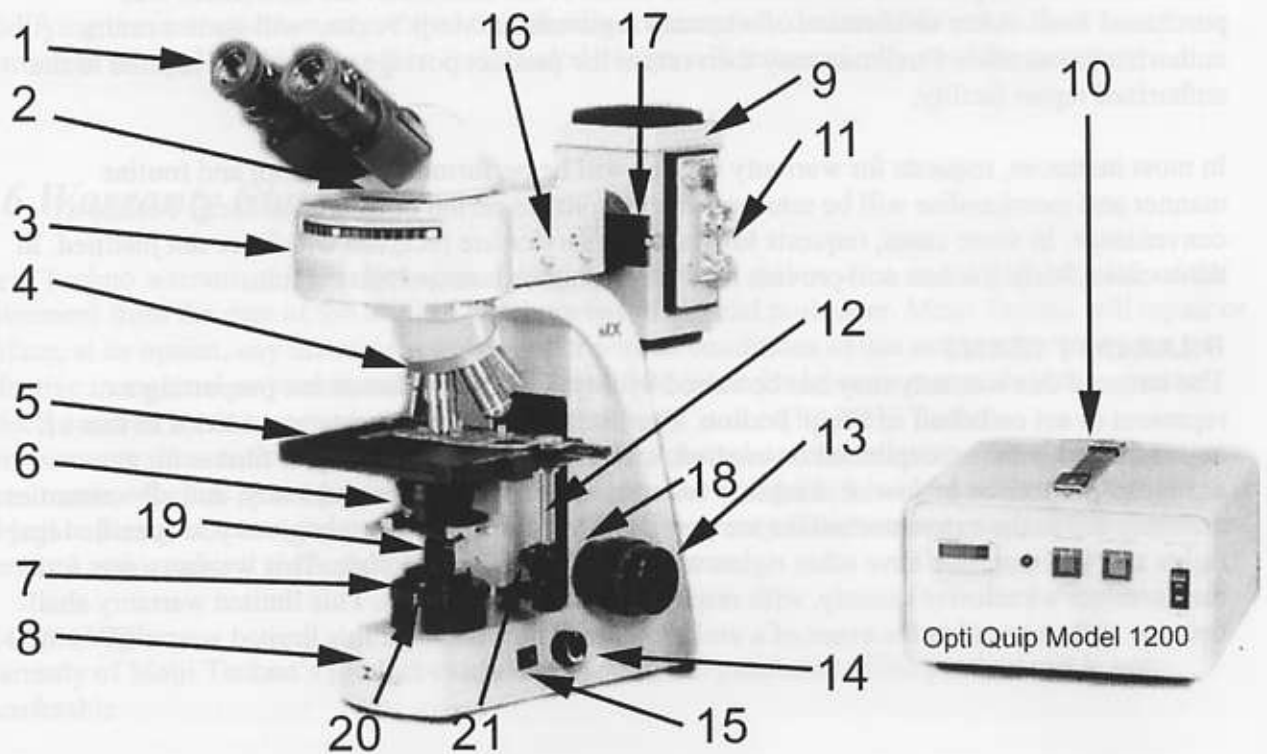

1. Eyepieces 10X (15X and 20X available as an option)
2. Siedentopf Binocular Head, 30° Inclination
3. MT-FL Modular Six Position Fluorescence Filter Module
4. Ergonomic Quintuple Nosepiece with Semi-Apo Objectives
5. Ceramic Coated Flat Top Stage
6. Abbe NA 1.25 Condenser
7. Field Iris For Transmitted Light Operation
8. Integrated Illuminator 6V 30W
9. FL-LHJ Epi-Fluorescence Lamphouse
10. FL-PWJ Epi-Fluorescence Power Supply
11. Lamp Centering Controls
12. Ergonomic drop down coaxial stage controls
13. Ergonomic Coarse and Fine Focus Knobs
14. Transmitted Light Brightness Control
15. Power Switch For Transmitted Light Operation
16. Incident Field and Aperture Iris Controls
17. Incident Filter Slider
18. Focus Tension Adjustment (use 2.5mm allen wrench)
19. Adjustable Stage Lock
20. Filter Tray on top of illuminator
21. Condenser Rack Height Adjustment Knob
22. Adjustable safety stop for stage height limit
23. Focusing collector lens knob

2.1 Installation Site

The microscope should be operated in a room with as little dust as practically possible. Keep your instrument away from solvents, chemical fumes and excessive humidity. Also try to avoid big swings in ambient temperature, direct sunlight and vibration as they can affect measurements and instrument performance.

Operating Ambient Conditions

Temperature: 10 - 36°C (50 - 96.8°F)

Relative Humidity: 0 - 80% up to 30°C (86°F)

2.2 Unpacking

Please check your packing slip to insure that all materials are present. Keep a copy for your records so that you have the proper information when ordering more equipment, ordering replacement parts or accessories or when calling for technical support. Please make sure that no small pieces or parts are left in the packing material. Keep the packing materials in a safe place for the purpose of storage and transporting the microscope and its accessories.

ATTENTION Avoid touching the surface of optical components such as lenses, filters and glass surfaces. Even very small traces of perspiration or finger oils can corrode the surfaces of optics in a short period of time.

2.3 Microscope Set Up

1. As a first step, remove all components from the shipping container and remove the packing materials. Save the container and packing in a dry location.
2. Place the microscope frame on a stable work surface.
3. Loosen the clamp screw on the microscope limb and install the Epi-Fluorescence Module (MT-FL) onto the microscope body and tighten down the clamp screw securely while the module is in the correct position.
4. Loosen the clamp screw on the top of the MT-FL Epi-Fluorescence Module with the hexagonal screw driver supplies with the microscope and install the prism house of the viewing head. Retighten the set screw by screw driver while the prism house is in correct position. Then, install the binocular on the prism house and securely tighten it with the supplied Allen key.
5. Install the FL-LHJ lamp house on the Epi-Fluorescence Module by inserting the Barrel of the lamp house into end of the Module while being guided by the Guide Pin on the end of the Module. And tight it by three set screws around the barrel with supplied Allen key.
6. Install the two eyepieces (MA817) by sliding them into the head and then install the rubber eyeshields on top of each eyepiece. **The eyepieces for MT6000 Series are a DIN standard 30mm diameter.**

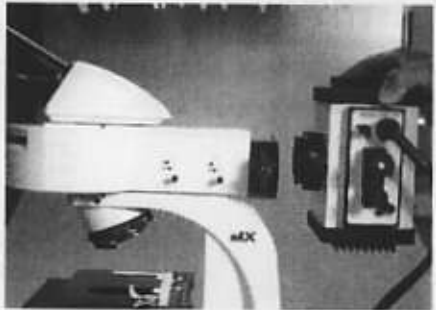
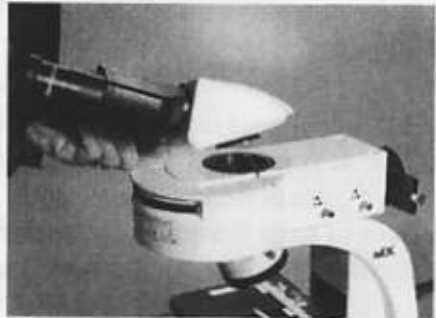

7. Connect the power cable from the FL-PWJ fluorescence power supply via the power socket on the rear of the Epi-Fluorescence Module.
8. Remove the objectives from their objective cases while being careful not to touch any part of the optics. Then, screw each objective into a nosepiece opening after removing each nosepiece dust plug. Install them incrementally or in order of power (e.g. 10, 20, 40 and 100).
9. Plug a power cord into the microscope and the other end into a grounded outlet.



⚠ CAUTION

The mains power cord should only be plugged into a known grounded outlet.

Contact your facilities technician if you are unsure of your mains outlet status. A simple outlet tester can be used to verify correct outlet polarity and the presence of a grounded circuit.

If no other accessories are going to be installed, the instrument is now ready for use.

2.4 Adjusting Interpupillary Distance

The Interpupillary Distance is essentially the distance between your two pupils expressed in millimeters. When set correctly, one will see one uniform round field of view or FOV. The adjustment is made by simply pulling apart or pushing together the eyetubes until a uniform round field is achieved. Make note of the number marked on the viewing head so you can repeat the setting later.

When you place a specimen on the stage, get it into focus with the right eye while your left eye is closed. Once the right side is in focus by using the fine focus knob on the microscope, open your left eye and use the diopter on the left eyetube to bring the left side in focus.

Once this is done, the microscope is adjusted to this user. Other users will have different IP's and different focusing abilities.

interpupillary distance



2.5 Fluorescence Filter Information

The epi-fluorescence equipped MT6000 includes the following two filter sets:

Excitation Type	Exciter Filter 25mm diameter	Dichroic Mirror 25.7mm X 36mm	Emitter Filter 25mm diameter	Applications
Blue Chroma P/N: 11001v 2	D470/40x	495DCLP	E515LPv2	FITC Acridine Orange Auramine EGFP, S65T, RSGFP
Green Chroma P/N: 11002v 2	D546/10x	565DCLP	E590LPv2	Rhodamine TRITC Propidium iodine RFP
UV Chroma P/N: 31000v2	D360/40x	400DCLP	D460/50m	DAPI Hoechst 33342, Hoechst 34580, AMCA, other

Published Chroma Technology Corp. Filter Set Performance Specifications:

11001v2 Blue

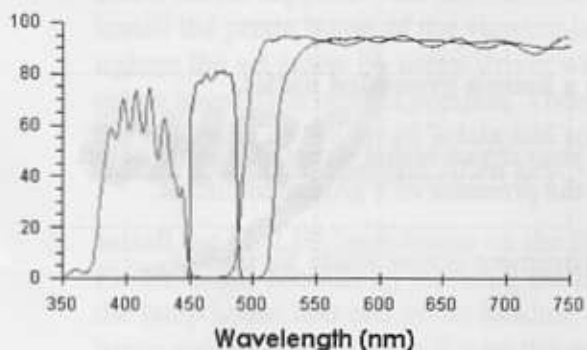

11002v2 Green

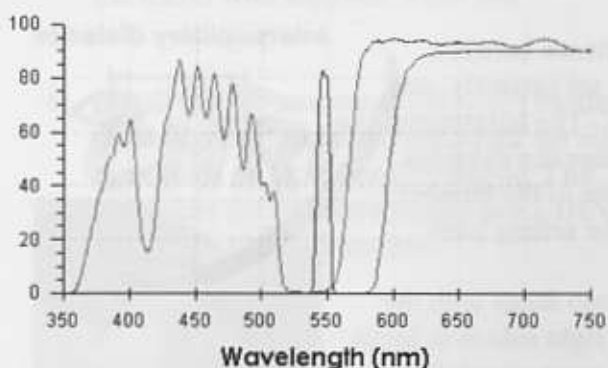

31000v2 UV

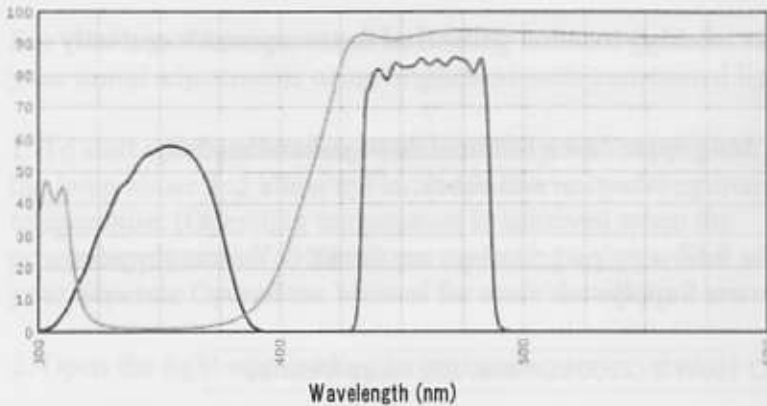

2.6 UV Light Safety Considerations

High Intensity DC arc lamps have substantial UV light content in their output. The U.S. National Institute for Occupational Safety and Health (NIOSH) recommends that exposure to UV energy be controlled and limited as much as practically possible.

Exposure to UV radiation even for very brief periods of time can be hazardous. The potential damage depends on exposure time, the type of UV light and the individuals sensitivity to UV.

UV light causes sunburn. Long term exposure can result in loss of skin elasticity initially and carcinoma eventually.

Absorption of UV light by the eyes will cause inflammation of the cornea called photo keratitis. Continued exposure can lead to the formation of cataracts on the eye lens.

Therefore, the following safety considerations should be taken very seriously:

- Limit access to areas where UV light is present.
- Post warning signs in the area where the equipment is installed.
- Always wear protective eyewear and gloves.
- Be sure your arms and neck are covered.
- Never directly look at the light source.
- Close off the light source with the filter slider when not being used.



3.0 Microscope Operation

Once the microscope has been setup in its working location with all of the components correctly installed, it is ready for use.

Your MT6000 is a precision instrument designed to last a lifetime. Always handle your microscope with care and avoid abrupt motion, vibration and shock.

For the Epi-Fluorescence Lamphouse, the following part numbers are the ONLY recommended replacement bulbs used with FL-PWJ Power Supply:

BA005	Replacement Mercury Lamp HBO 100W/2 (2200 Lumens, 200 hours lifetime)
--------------	---

For the transmitted or incident light, do not install any bulb in your instrument other than the ones designated by Meiji Techno:

MA326	6V 30W Halogen	For Integrated Transmitted Illuminator Models MT6200, MT6300
--------------	----------------	--

Always disconnect the power cord from the back of the microscope when not being used, or when cleaning your instrument or when making any repairs.

CAUTION

Avoid Dismantling

Never attempt to dismantle the instrument. This will void your warranty and could possibly lead to the instrument no longer performing accurately.

3.1 Incident Light Operation - Epi-Fluorescence

For viewing of transparent objects using incident-light fluorescence, we recommend to first make your initial adjustments using brightfield with transmitted light.

1. To start epi-fluorescence, switch on the power supply to the lamp house and allow the lamp to achieve operating temperature. (Operating temperature is achieved when the power supply settles on the proper operating voltage. See your Separate Operations Manual for more details.)

2. Open the light stop leading to the lamphouse.

3. Move filter block into the light beam path.

4. Place the 10X objective currently in the light path.

5. Place a sheet of white paper on the specimen stage.

6. Observe if the arc image is clearly projected and centered in the light spot as shown in Figure X. (If not, proceed to the section in the Lamp house Manual describing Mercury Lamp arc position adjustment.)

a. Upper knob moves the Mercury lamp horizontally.

b. Lower knob moves the mercury lamp vertically.

c. Focusing collector lens knob.

7. Remove the paper and re-install the objective.

8. Position a known fluorescing specimen on the stage.

9. Using a lower power objective like the 10X, check to see if the image is illuminated evenly. If not, adjust the settings on the FL-LHJ house if needed.

The two electrodes of the arc can be seen in the extension of the plane of the discharge arc. Refer to the Lamphouse Manual for further information and adjustment instructions.

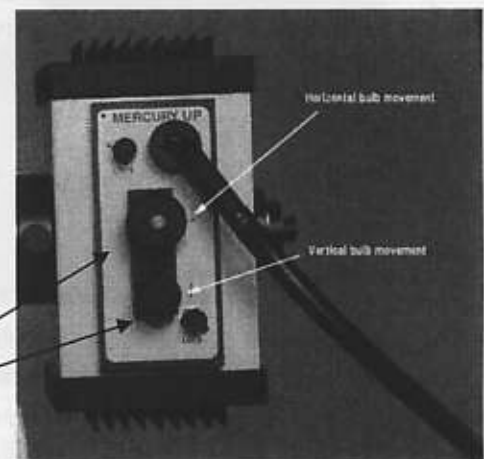
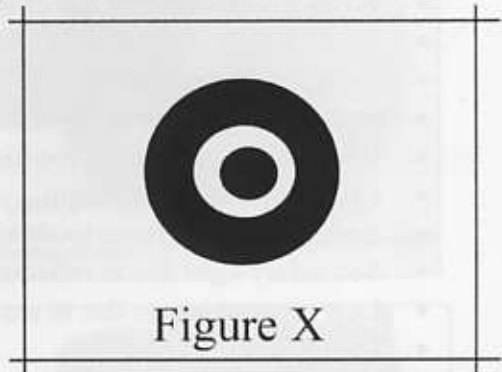

Possible Incident Light Fluorescence Operational Problems

If normal adjustments are not getting the results you expect, check these:

- Weak fluorescence or image intensity: specimens improperly stored or too old
- Rapid fading of specimens i.e.: specimen is photobleached
- Unspecific or erroneous filter combination
- Numerical aperture of objectives too low
- Eyepiece magnification too high
- Failing or old DC arc lamp
- Ambient light or room too bright
- Secondary light due to reflection at condenser
- Low contrast image due to excitation bandwidth too wide
- Unspecified staining
- Mounting medium is fluorescing
- Auto-fluorescence of objective or immersion oil
- Dirty optics

MT6000 Epi-Fluorescence Objectives

Epi-Fluorescent Objectives – Semi-Apo Planachromat - Infinity Corrected - F = 200mm	
MA844	Semi Apo Planachromat F10X objective, NA: 0.40, WD = 1mm, (standard)
MA845	Semi Apo Planachromat F20X objective, NA: 0.65, WD = 0.7mm, (standard)
MA846	Semi Apo Planachromat F40X objective, NA: 0.82, WD = 0.15mm, (standard)
MA848	Semi Apo Planachromat F100X oil objective, NA: 1.25, WD = 0.2mm, (standard)

3.2 Transmitted Light Operation – Brightfield

1. First, set your interpupillary distance on the microscope eyetubes by pulling them apart or pushing them closer together to fit your eyes. When set correctly, one will see one uniform round field of view. Make note of the distance setting when adjusted to your liking so you can later repeat the setting.

2. Turn on the microscope power switch which is located as shown at right. Adjusting the brightness desired is done with the variable brightness control knob shown at right.

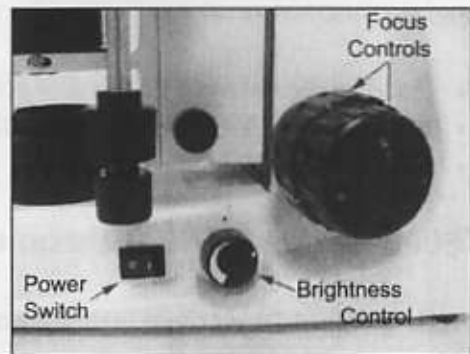

3. Make sure the field iris diaphragm is opened all the way to the right (rotate clockwise) to start. Refer to picture at right.

4. We recommend that you initially use a specimen that has areas of high and low contrast. Place that specimen on the stage.



5. Select a lower power "scanning" objective like the 4X or the 10X to find the area of interest on the specimen quickly. Be sure the objective "clicks" into place when you turn the objective nosepiece.

6. By using the coarse and fine focus knobs shown above, adjust your specimen into focus with your left eye closed (looking only through the right eyetube). With the specimen in focus, close the right eye you just used and open the left. If the specimen is out of focus for the left eye, adjust the diopter on the eyetube until the focus is correct. The microscope is now adjusted for this user. Focusing eyetubes allows us to compensate for users that wear corrective eye lenses. If you wear glasses, you may want to remove the rubber eyeguards.

7. The field iris diaphragm located on the condenser can be "stopped down" or closed somewhat to give the observation of your specimen more or less contrast or resolving power. Stopping down the diaphragm decreases resolution and brightness but increases image contrast and depth of focus.

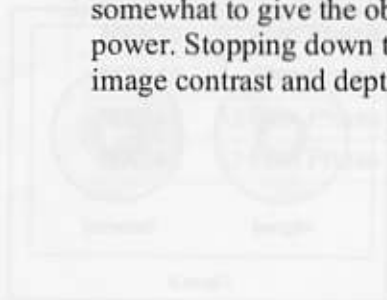

Possible Brightfield Mode Operational Problems

If normal adjustments are not getting the results you expect, check to see if these conditions exist:

- Incorrect condenser / objective combination being used
- Incorrect components inadvertently installed
- Dirty or smudged optics

MT6000 Series U Planachromat Brightfield Objectives

Brightfield Objectives – U. Planachromat - Infinity Corrected - F = 200mm	
MA830	U Planachromat 2.5X objective, NA: 0.07, WD = 5.7mm (optional)
MA831	U Planachromat 4X objective, NA: 0.10, WD = 25.9mm (included)
MA832	U Planachromat 10X objective, NA: 0.25, WD = 10.7mm (included)
MA833	U Planachromat 20X objective, NA: 0.40, WD = 7.29mm (optional)
MA834	U Planachromat 40X objective, NA: 0.65, WD = 0.5mm (included)
MA835	U Planachromat 50X objective, NA: 0.87, WD = 0.28mm (optional)
MA837	U Planachromat 100X oil objective, NA: 1.25, WD = 0.23mm (included)

3.3 Transmitted Halogen Light Operation – Phase Contrast

Phase contrast is a very useful technique for high-contrast images of unstained or transparent specimens mounted on glass slides. Phase Contrast models feature a powerful 30W halogen lamp for extra bright phase contrast image relief. The MT6000 Series Phase Contrast Models can set up with an optional 10X, 20X, 40X and 100X U. Plan Phase objectives and Zernike Phase Condenser.

1. Install the phase contrast objectives into the nosepiece and install the Zernike Phase Contrast Condenser in place of the standard Abbe Condenser by lowering the condenser rack and loosening the clampscrew shown at right and then sliding out the condenser.



2. Remove the right hand eyepiece and insert the centering telescope. Then, rotate the 10x objective into place along with the corresponding 10X-20X condenser annulus.

3. Focus the centering telescope while looking through it until the light and dark rings seen are in sharp focus.

4. If the annuli are not centered as shown in Figure 3, move the knurled push-pull annuli adjustment rings on the bottom of the Zernike phase condenser with your fingers to adjust the phase condenser annulus with each phase objective as shown at right.

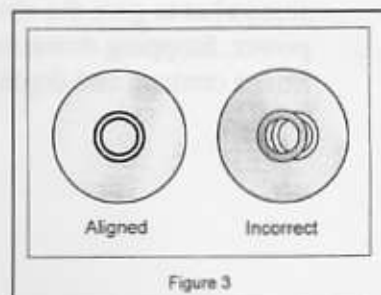

3.5 Photomicroscopy

5. Repeat the process for the rest of the positions being sure to match the annulus to the right objective.

6. Remove the centering telescope and re-install the eyepiece.

The microscope is now properly set for phase contrast observation mode.

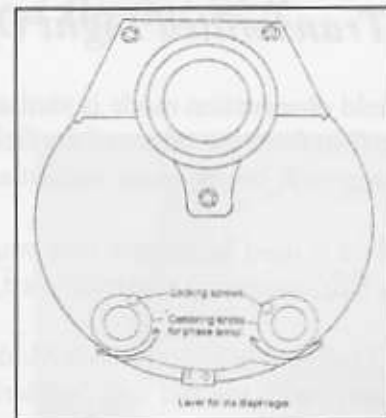

- Phase images will photograph and appear their best when the green interference filter 546nm (MA861/05) is placed into the light path since achromatic objectives are spherically corrected for green light and the human eye picks up the green wavelength spectrum best.

Possible Phase Contrast Mode Operational Problems

If normal adjustments are not getting the results you expect, check these:

- Wrong phase annulus being used.
- Phase annulus not centered correctly.
- Wrong condenser installed.
- Aperture diaphragm is completely closed.
- Halos around the outlines of details are optical artifacts which may obscure details of your specimen. This is a known limitation of phase contrast microscopy.
- Since phase annuli limit the numerical aperture of the optical system, image resolution may suffer somewhat.
- If the specimen being observed is too thick, phase shifting will distort the image details.

Phase Contrast Objectives for MT6000 Series (Optional)

Phase Contrast Objectives - Planachromat - Infinity Corrected - F = 200mm	
MA839	U Plan Phase 10X objective, NA: 0.25, WD = 10.7mm,
MA840	U Plan Phase 20X objective, NA: 0.40, WD = 7.29mm,
MA841	U Plan Phase 40X objective, NA: 0.65, WD = 0.5mm,
MA842	U Plan Phase 100X objective, NA: 1.25, WD = 0.23mm,

3.4 Transmitted Light Operation – Darkfield

Darkfield observation mode is similar to brightfield except that only indirect or oblique light that is “bent” in from the edges of the field of view is illuminating the specimen. The result is a specimen with bright edges against a dark background or “darkfield”.

Darkfield is used to observe very small living aquatic organisms, diatoms, small insects, bone, fibers, hair, unstained bacteria, yeast, cells, protozoa and other biological specimens.

Meiji Techno’s MT6000 Series Models have optional 50X and 100X oil immersion Plan Objectives with iris and optional darkfield condenser with NA of 1.25 in a dovetail mount

Setting Up Darkfield Observation Mode

The following instructions assume you have a prepared slide with cover slip.

1. Install the darkfield objectives into the nosepiece.
2. Remove the standard condenser by loosening the thumbscrew holding the condenser assembly and simply sliding the condenser towards yourself. You might rack down the condenser to make the access easier. Slide in the darkfield oil-immersion condenser in place and snug the thumbscrew.
3. To check to see if the darkfield condenser is centered, look into the eyetubes with the regular 10X objective in position. If the iris cannot eclipse the darkfield stop correctly, adjust the condenser thumbscrews until the stop can be centered properly.
4. Place a drop or two of immersion oil on the center of the top of the condenser and move up the condenser rack to the required height, i.e. the immersion oil is in contact with the bottom of the specimen slide.
5. Place a drop of oil onto the cover slip above your specimen and slowly and carefully rotate the 50X darkfield oil objective or the 100X darkfield oil objective into the drop of oil that is on top of the cover slip. Adjust the focus of your specimen.

The microscope is now in darkfield observation mode.

3.5 Photomicrography with 35mm SLR and Digital SLR Cameras

The MT6300H uses a trinocular tube with integrated male "C" mount on top of the head for photomicroscopy.

In order to secure a 35mm SLR camera body to this microscope, an optional camera attachment tube (MA150/50 or MA150/60) will need to be used with the corresponding T2 Adapter Ring that matches the camera to be used.

The table below shows the different cameras and adapter rings that can be used:

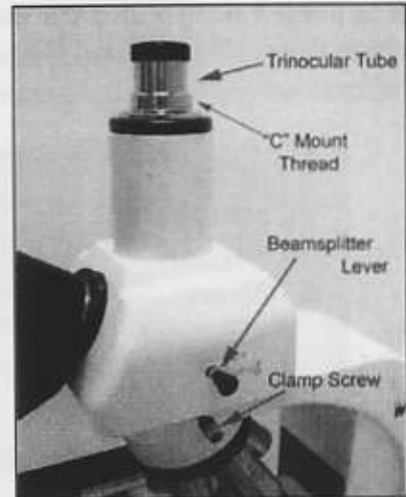

T2 Camera Adapter Rings

T2-1	Canon
T2-2	Minolta
T2-3	Pentax K
T2-4	Pentax S (threaded)
T2-5	Nikon
T2-6	Olympus
T2-7	Contax, Yashica
T2-8	Konica
T2-9	Canon EOS
T2-10	Minolta Alpha / Maxim 2000

Photoeyepieces

In addition, a photo eyepiece will be needed to make an image for the camera. The table below shows the different photo eyepieces that are available:

MA512	2.5X Photo eyepiece
MA508	5X Photo eyepiece
MA500	3.3 Photo eyepiece

3.6 Photomicrography with Digital Still Cameras

In order to mount a consumer grade digital camera to this microscope, an optional camera adapter will be needed along with a trinocular head model MA816. The table below shows the different cameras that can be used and their corresponding adapter part number:

Digital Camera Adapter Chart	Canon Powershot G1, G2	Canon Powershot G3, G5	Canon Powershot G6	Nikon Coolpix 800, 900, 900S, 950, 990, 995 & 4500	Nikon Coolpix 5000
MT4300, MT5300, MT6300, MT7300, MT7530, MT8300, MT8530, MT9300 Series Microscopes	<u>MA151/30/43</u>	<u>MA151/30/41</u>	<u>MA151/30/31</u>	<u>MA151/30/51</u>	<u>MA151/30/71</u>

Nikon Coolpix 4300, 885	Olympus Camedia C-2000, C-2020, C-3000, C-3030, C-3040, C-3100, C-4040, C-4100, C-5050	Olympus Camedia C-700, C-720, C-730, C-740, C-750, C-755, C-760, C-765, C-770	Olympus Camedia C-5060, C-7070	Fuji Finepix S602, 4900Z, 6900Z, S5000, S7000	Sony S70, S75, S85, CD300, CD400, CD500
<u>MA151/30/57</u>	<u>MA151/30/61</u>	<u>MA151/30/63</u>	<u>MA151/30/65</u>	<u>MA151/30/81</u>	<u>MA151/30/91</u>

3.7 Connecting a Video or Other Camera that has a "C" type mount

In order to attach a camera that employs a standard "C" type camera mount to the this MT6300 microscope, one can use the integrated male "C" mount by unscrewing and removing the chrome tube.

To change the magnification seen by the camera, an optional "C-Mount" camera attachment WITH LENS can be used on top of the trinocular port of the microscope:

Optional "C" Mounts With Lenses - For all Meiji Trinocular Microscopes	
MA151/35/03	"C" Mount Adapter with 0.30X lens (Slips over existing photo tube)
MA151/35/04	"C" Mount Adapter with 0.45X lens (Slips over existing photo tube)
MA151/35/15	"C" Mount Adapter with 1.0X lens (Slips over existing photo tube)
MA151/35/20	"C" Mount Adapter with 0.7X lens (Slips over existing photo tube)
MA151/35/25	"C" Mount Adapter with 2.5X lens (Slips over existing photo tube)

4.0 Maintenance and Cleaning

WARNING

- Disconnect the power cord on your equipment prior to performing cleaning, maintenance or repair.
- Keep electrical components away from moisture or humidity.
- In warm humid climates, take special care to prevent your equipment from exposure to fungal growth.
- Clean the microscope after each use. Keeping your microscope clean will insure its proper operation over its lifetime.

Dust Protection

Be sure to use the supplied dust cover with your microscope after each work session.

Cleaning

Dust and fibers can cause "background fluorescence" during fluorescence microscopy so keeping your microscope clean can help the overall quality of your work.

Cleaning of Painted Surfaces

Use a soft brush or lint-free cotton cloth to removed dust and loose particles.
Tough dirt can be removed with a water and a mild detergent.

CAUTION NEVER USE ACETONE OR OTHER HARSH CHEMICALS.

Painted or plastic surfaces should not be tarnished or etched with cleaning agents that are too powerful.

To clean painted surfaces, use a moistened lint-free cotton cloth with mild soapy water.

Cleaning the Stage

Use a soft brush or lint-free cotton cloth to removed dust and loose particles.

DO NOT USE ACETONE OR OTHER HARSH CHEMICALS. Use a moistened lint-free cotton cloth with a solution of mild soapy water.

Cleaning of Glass Surfaces

Use a soft brush or lint-free cotton cloth to removed dust and loose particles.

For tough dirt, use a soft lint-free cotton cloth moistened with distilled water.

If that fails, try using medical or reagent grade isopropyl alcohol.

Cleaning Objectives

DANGER

Objectives should NEVER be disassembled for cleaning or for any other reason! We do not advise cleaning the inside surfaces of objectives or eyepieces.

Use a soft brush, bellows brush or a soft lint-free cotton cloth to removed dust and loose particles.

For tough dirt, use a soft lint-free cotton cloth moistened with distilled water.

If that fails, carefully try using medical or reagent grade isopropyl alcohol.

Wipe lenses immediately. Over time, water and solvents can dissolve optical cements that hold optics together so NEVER soak objectives with ANY type of fluid.

5.0 Troubleshooting

Meiji Techno products are manufactured exclusively in Japan under ISO9001 manufacturing standards. However, if you ever have any difficulty with any Meiji product, feel free to contact us at:

MEIJI TECHNO CO., LTD.
322-1, Chikumazawa,
Miyoshi machi, Iruma-gun
Saitama 354-0043, Japan

Phone: 049-259-0111
Fax: 049-259-0113
E-mail: meiji@meijitechno.co.jp
Web: <http://www.meijitechno.co.jp>

Meiji Techno America
3010 Olcott Street
Santa Clara, CA 95054-3207

Phone: 800.832.0060
Fax: 408.970.5054 FAX
E-mail: technicalsupport@meijitechno.com
Web: <http://www.meijitechno.com>

Our technical staff is trained to assist you on mechanical or electrical issues you may have.

Operational Issues

Please refer to the previous "Operations" chapters which coincide with the observation mode that you are using. The most common operational problems include the improper positioning of contrast accessories, the improper adjustment of phase annuli or the incorrect condenser installed. If you are unable to obtain the desired image from the microscope, please refer to the corresponding chapters of this manual under the proper operation mode: brightfield, phase contrast, etc.

Electrical Problems

Electrical problems can include:

- The lamp on the microscope is not working.
- No voltage is present.

Check the following probable causes:

- Check that all power cords are properly connected to the right spots.
- Make sure power is actually present at the wall outlet.
- Check to see if there is a fuse is blown.

5.1 Replacing the mains fuse on the microscope

CAUTION

ALWAYS DISCONNECT YOUR EQUIPMENT BEFORE DOING ANY REPAIR.

Location of Mains Fuse

The mains fuse of the MX Series Microscopes is located on the back panel of the microscope as shown.

Instructions to replace the mains fuse:

- Turn the power switch to the off position.
- Unplug the microscope from the wall outlet.
- Loosen the fuse cap from the fuse holder.
- Remove the blown fuse from the fuse cap.
- Replace the fuse with the CORRECT type and rating which is: IEC Standard 5 X 20mm 3amp Fast-Acting such as Littelfuse 217 Series or Bussmann GDB Series
- Reinstall the fuse holder with the new fuse installed.

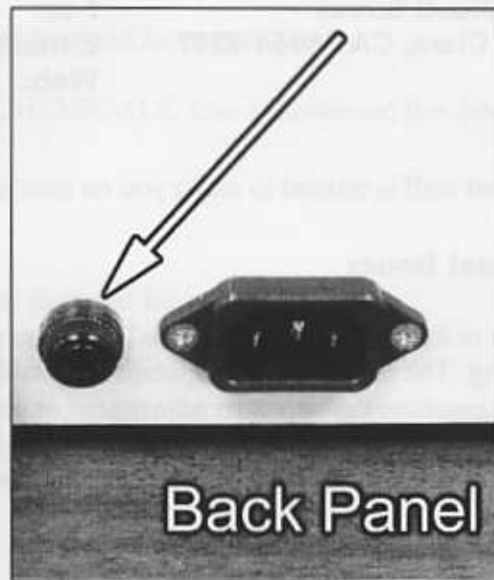

DANGER

NEVER USE REPLACEMENT FUSES OF A DIFFERENT RATING.

5.2 Integrated Transmitted Light does not work

- Make sure the plug from the lamp is firmly plugged into the correct socket on the rear panel.
- Check to see if the mains fuse has blown.
- Check to see if the lamp has blown.

5.3 Replacing the 6V 30W Halogen Light

CAUTION

ALWAYS DISCONNECT YOUR EQUIPMENT BEFORE DOING ANY REPAIR.

Do not touch the glass envelope of the lamp during installation. Keep the protective sleeve or bag of the lamp during installation and remove it right after installation.

HOT!

LAMP AND LAMP HOUSING MAY BE HOT TO THE TOUCH.

- Switch off the microscope.
- Disconnect the power cord.
- Wait until the housing and bulb have cooled sufficiently.
- Lay the scope on it's side on top of a towel or blanket
- Remove the bottom illuminator cover screw and lift the cover to remove.
- Replace the defective lamp.
- Place a new lamp into the socket while avoiding touching the glass. Notice the bulb is wrapped in plastic. Use it to avoid touching the glass envelope during installation.
- Be sure the bulb is pushed in as far as possible thereby aligning the filament in the illuminator.
- Reinstall the lamp cover door.
- Reconnect the power cord and switch on the microscope to verify proper illuminator operation.

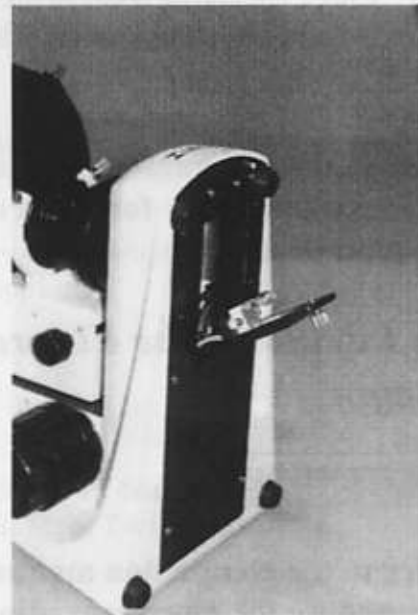

5.4 Fluorescence Lamp does not work



LAMP HOUSE MAY BE HOT TO THE TOUCH.

Do not touch the glass envelope of the lamp at any time. Keep the protective sleeve or bag of the lamp during installation and remove it right after installation.

- Make sure that all cable connections between the lamp house, power unit and mains are all properly established.
- Check if the lamp house power unit main fuse is intact.
- Check the logged hours of the lamp for an excess of 400 hours.
- Be sure lamp is operating in the right orientation, i.e. bulb is installed in correct position.



Refer to the companion manual of the Nobska Lamphouse for more on troubleshooting.

5.5 Replacing the Fluorescence Lamp



Refer to the companion manual of the Lamphouse for more regarding replacement of the lamp.

Replacing the mercury HBO lamp within the Nobska housing is not very complex but there is a followed procedure that will make the process easier and less dangerous.

If the glass envelope of the mercury bulb happens to break open, you and the immediate environment could be exposed to mercury which is a known biohazard.

Please refer to the manual which came with your Nobska Lamp House for information and instructions for replacing, adjusting and burning in your new mercury lamp.

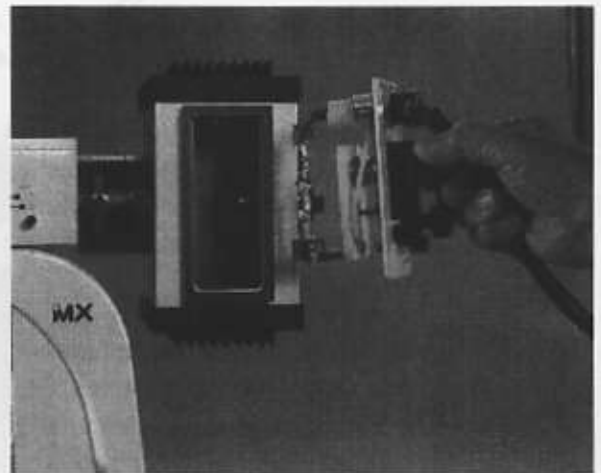

6.0 Storage

Protect your microscope from dust after each use by covering your instrument with the protective dust cover that came with your microscope.

Store your microscope in a cabinet that has a stable temperature and low humidity.

If you live in an area that has high humidity, consider storing your microscope in a sealed container along with a desiccant such as silica gel.

It is also recommended that the objective and eyepieces be stored in a separate air tight container with desiccant.

7.0 Packing and Transport

Whenever the microscope is going to be moved, ship or transport the microscope and the accessories in its original packing.

It is advisable to keep a copy of all necessary information: copy of the original invoice, the operations manual, etc. included with the microscope when shipping.

8.0 Accessories and Replacements Parts

Part numbers and product descriptions for accessories and parts for MT Series Microscopes can be found listed below. Accessories and replacement parts for all Meiji Techno products are available through our dealer network.

Feel free to contact us a call so we may direct you to the closest authorized Meiji Techno Dealer in your area. Call us toll free (800) 832-0060 Monday through Friday 9am – 5pm PST.

MT6000 Series Components & Accessories

Viewing Heads	
Part Number	Description
MA815	Siedentopf type binocular head, 30° inclined, 30mm I.D. eyetubes (included with MT6200H)
MA816	Siedentopf type trinocular head, 30° inclined, 30mm I.D. eyetubes (included with MT6300H)
MA957	Siedentopf Ergonomic type binocular head, adjustable 10 - 50° inclination, 30mm I.D. eyetubes (optional)
Eyepieces	
Part Number	Description
MA817	SWH10X Super Widefield High Eyepoint eyepiece, F.N.22 (included) (accepts 25mm reticle)

MA818	SWH15X Super Widefield High Eyepoint eyepiece, F.N.16 (optional) (accepts 19mm reticle)
MA819	SWH20X Super Widefield High Eyepoint eyepiece, F.N.12 (optional) (accepts 19mm reticle)
MA859	SWH10X-F Super Widefield High Eyepoint <u>focusing</u> , F.N.22 (optional) (accepts 25mm reticle)
Optional U Plan Brightfield Objectives – U.Planachromat - Infinity Corrected - F = 200mm	
MA830	U Planachromat 2.5 objective, NA: 0.07, WD = 5.7mm, (optional)
MA831	U Planachromat 4X objective, NA: 0.10 WD = 25.9mm, (optional)
MA832	U Planachromat 10X objective, NA: 0.25, WD = 10.7mm, (optional)
MA833	U Planachromat 20X, objective, NA: 0.40, WD = 7.29mm, (optional)
MA834	U Planachromat 40X objective ,NA: 0.65, WD = 0.5mm, (optional)
MA835	U Planachromat 50x objective, NA: 0.87, WD = 0.28mm, (optional)
MA837	U Planachromat 100X objective, NA: 1.25, WD = 0.23mm, (optional)
Optional U Plan Phase Contrast Objectives – Infinity Corrected - F = 200mm	
MA839	U Planachromat Phase 10X objective, NA: 0.25, WD = 10.7mm (optional)
MA840	U Planachromat Phase 20X objective, NA: 0.40, WD = 7.29mm (optional)
MA841	U Planachromat Phase 40X objective, NA: 0.65, WD = 0.5mm (optional)
MA842	U Planachromat Phase 100X objective, NA: 1.25, WD = 0.23mm (optional)
Standard Epi-Fluorescent Objectives – Semi Apo Planachromat - Infinity Corrected	
MA844	Semi Apo Planachromat F10X objective, NA: 0.40, WD = 1mm (Included)
MA845	Semi Apo Planachromat F20X objective, NA: 0.65, WD = 0.7mm (Included)
MA846	Semi Apo Planachromat F40X objective, NA: 0.82, WD = 0.15mm (included)
MA848	Semi Apo Planachromat F100X oil objective, NA: 1.25, WD = 0.2mm (included)
Optional Darkfield Oil Immersion Objectives – U.Planachromat - Infinity Corrected	
MA836	U Plan Objective 50X oil objective with iris, NA: 0.87, WD = 0.28mm (optional)
MA838	U Plan Objective 100X oil objective with iris, NA: 1.25, WD = 0.23mm (optional)
Condensers	
MA913	Six Position Zemike Phase Condenser with darkfield stop, blackout position and iris in dovetail mount (optional)
MA914	Darkfield Oil Immersion Condenser, N.A. 1.25 in dovetail mount (optional)
MA910	Abbe Condenser, N.A. 1.25 with iris in dovetail mount (included)
Filters	
MA861/05	Green interference filter in 40mm, un-mounted, 546nm (optional)
MA856/05	Blue filter, LB100, in 40mm, un-mounted (included)
MA857/05	Green filter, G533, in 40mm, un-mounted, 533nm (optional)
MA858/05	ND25 Neutral density filter, in 40mm, un-mounted (transmission: 25%) (optional)
MA860	Neutral density filter in 29.8mm mount (fits epi-illuminator) (included)
Miscellaneous Parts & Accessories	
MA918R	Ceramic coated flat top stage 191mm x 126mm with right-handed with drop down coaxial controls (100mm x 100mm travel)
MA918L	Ceramic coated flat top stage 191mm x 126mm with left-handed with drop down coaxial controls (100mm x 100mm travel)
MA598	Replacement finger assembly for MA918R and MA918L Stages
MA676	Attachable clinical specimen holder for MA918R and MA918L (optional)

MA958	Photo/Video attachment with 80/20 beamsplitter for MA957 Ergonomic Head
MA809/10	Replacement 115V AC Power cord with plug (USA)
MA809/20	Replacement 220V AC Power cord with plug (Eurocord)
MA809/30	Replacement 230V AC Power cord with plug (UK)
MA809/40	Replacement 240V AC Power cord with plug (Australia)
MA915	Polarizing set for MT6000 Series Models (optional)
MA458/05	Centering Telescope for phase contrast, O.D.= 30.0mm (included in phase models)
MA523	Cross-Line Reticle, 25mm diameter (optional)
MA506	10mm divided into 100 parts, 25mm diameter (optional)
MA509	5mm divided into 100 parts, 25mm diameter (optional)
MA524	10mm square divided into 400 parts, 0.5mm square, 25mm diameter (optional)
MA510	10mm square divided into 100 parts, 1.0mm square, 25mm diameter (optional)
MA542	Cross-Line Reticle with 0.1mm graduation, 25mm diameter (optional)
MA285	Stage Micrometer, 1mm divided into 100 parts, 0.01mm (optional)
MA286	Stage Micrometer, 0.04" divided into 40 parts, 0.001" (optional)
MA906	Eyeshield for MA817 SWH10X Eyepiece (ea) (pair included)
MA326	Replacement Lamp, 6V 30W halogen (optional)
MA327	Replacement Fuse, 3A for Halogen models (optional)
MA929	Replacement Fuse, 0.5A for LED Illuminated models (optional)
MA960	Dust Cover for MT6200 & MT6300 (included)
Epi-Fluorescent Parts & Accessories	
MT-FL	Six-Position Fluorescent Illuminator Attachment with 3 Filter Sets (includes MA865/05 Basic Blue Excitation Filter Set, MA866/05 Basic Green Excitation Filter Set and MA867/05 Basic U Excitation Filter Set) (included)
FL-LHJ	XBO/HBO Nobska Lamphouse (included)
FL-PW	Opti-Quip Power supply for Nobska Lamphouse Model 1200 (included)
TW-08	Trigger wire for Nobska Lamphouse (included)
BA005	Mercury Lamp HBO 100W/2 (included)
BA013	Replacement Xenon Lamp XBO 75W/2 (optional)
BA014A	Replacement Xenon Lamp XBO 100W (optional)
MA865/05	Basic Blue Excitation Filter set (Chroma Part Number: 11001V2) (included)
MA866/05	Basic Green Excitation Filter set (Chroma Part Number: 11002V2) (included)
MA867/05	Basic U Excitation Filter set (Chroma Part Number: 31000V2) (included)
MA867	Additional (empty) filter cube set for MT6000 (optional)

9.0 Technical Descriptions

Filters and Applications

<u>Filter</u>	<u>Application</u>
ND25	Neutral Filter or ND Filter. Grey filters or neutral density filters are used to attenuate all frequencies of light equally resulting in preservation of color temperature. The ND25 filter would indicate a reduction of light transmission by 75 percent or a passage of light of 25 percent.
ND13	The ND13 filter would indicate a reduction of light transmission by 87 percent or a passage of light of 13 percent.
Green Interference	Contrast enhancement for phase contrast observation mode.
LB100	Color Temperature Blue Filter. Suppresses red wavelengths in fluorescence applications. Provides a mired shift of -100.
G533	Green Filter. Provide contrast enhancement of complimentary colors of blue and red on black & white or tungsten-balanced color transparency films.

10.0 Physical Dimensions

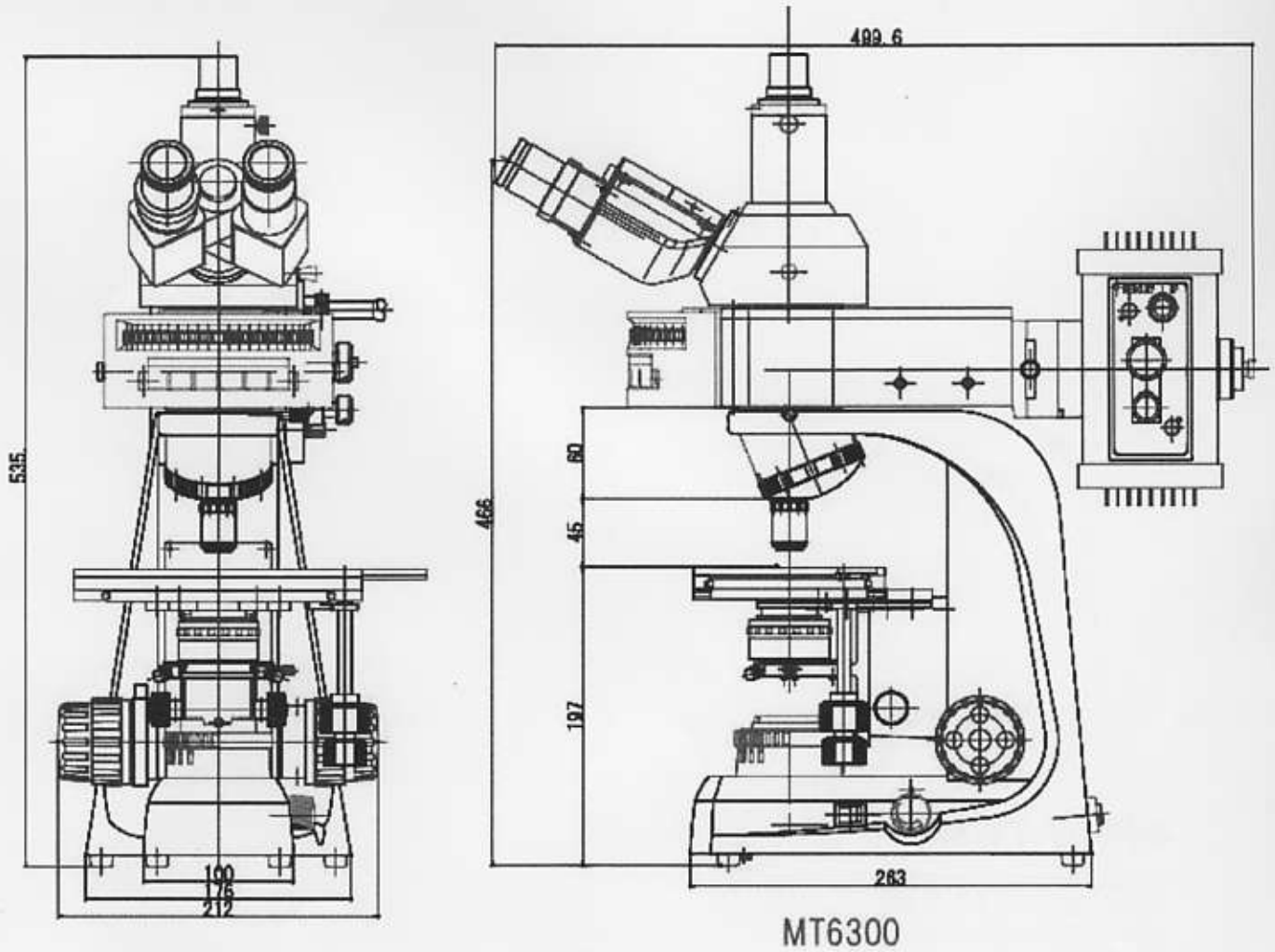

Meiji Techno Co. Ltd.



MEIJI TECHNO CO., LTD.
322-1, Chikumazawa,
Miyoshi machi, Iruma-gun
Saitama 354-0043, Japan

Phone: 049-259-0111
Fax: 049-259-0113
Email: meiji@meijitechno.co.jp
Web: <http://www.meijitechno.co.jp>

MEIJI TECHNO AMERICA
3010 Olcott Street
Santa Clara, CA 95054-3207

Toll free: (800) 832-0060
Phone: (408) 970-4799
Fax: (408) 970.5054
E-mail: sales@meijitechno.com
Web: <http://www.meijitechno.com>

MEIJI TECHNO UK, LTD.
The Vineyard, Axbridge
Somerset, BS26 2AN

Phone: 01934 733655
Fax: 01934 733660
Email: enquiries@meijitechno.co.uk
Web: <http://www.meijitechno.co.uk>